

Operation Guide 5346

CASIO®

Getting Acquainted

Congratulations upon your selection of this CASIO watch. To get the most out of your purchase, be sure to read this manual carefully.

About This Manual

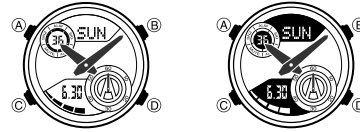

- Depending on the model of your watch, display text appears either as dark figures on a light background or light figures on a dark background. All sample displays in this manual are shown using dark figures on a light background.

E-1

- Button operations are indicated using the letters shown in the illustration.
- Each section of this manual provides you with the information you need to perform operations in each mode. Further details and technical information can be found in the "Reference" section.

Contents

| | |
|-------------------------------------|------|
| General Guide | E-6 |
| Timekeeping | E-8 |
| Stopwatch | E-14 |
| Countdown Timer | E-17 |
| World Time | E-20 |
| Alarms | E-24 |
| Illumination | E-29 |
| Hand Home Position Correction | E-33 |
| Reference | E-35 |
| Specifications | E-40 |

E-2

E-3

Procedure Lookup

The following is a handy reference list of all the operational procedures contained in this manual.

| | |
|---|------|
| To set the time and date | E-9 |
| To change the Daylight Saving Time (summer time) setting | E-12 |
| To use the countdown timer | E-18 |
| To configure countdown start time settings | E-19 |
| To view the current time in another time zone | E-21 |
| To toggle a city code time between Standard Time and Daylight Saving Time | E-22 |
| To swap your Home City and World Time City | E-23 |
| To set an alarm time | E-25 |

E-4

| | |
|--|------|
| To test the alarm | E-26 |
| To turn an alarm on and off | E-27 |
| To turn the Hourly Time Signal on and off | E-28 |
| To illuminate the display manually | E-29 |
| To specify the illumination duration | E-30 |
| To turn the auto light switch on and off | E-32 |
| To adjust home positions | E-33 |
| To turn the button operation tone on and off | E-36 |

E-5

General Guide

- Press (C) to change from mode to mode.
- To return to the Timekeeping Mode from any other mode, hold down (C) for about three seconds.
- In any mode (except a setting mode), press (B) to illuminate the display.

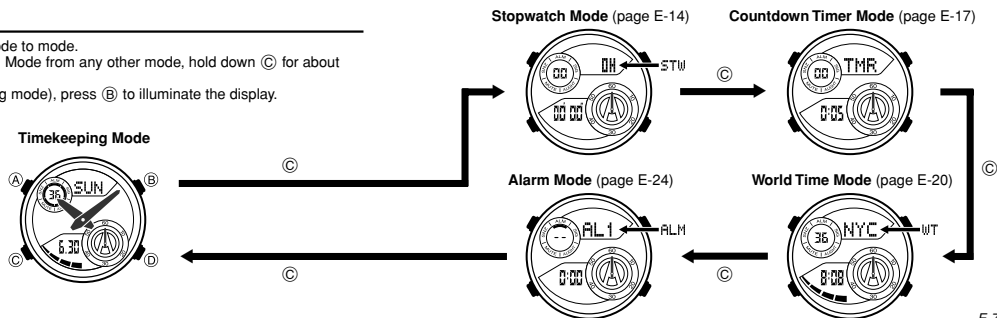

E-6

E-7

Timekeeping

You can adjust the Home city date and time in the Timekeeping Mode.

- Pressing (A) in the Timekeeping Mode will toggle the lower display between the screens shown below.

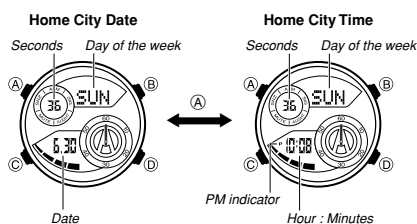

E-8

To set the time and date

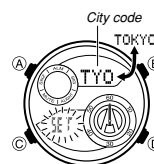

- In the Timekeeping Mode, hold down (A) for about two seconds until "SET" appears on the lower display. This is the setting mode.
 - Note that keeping (A) depressed too long (for about five seconds) will cause a different type of setting mode to be entered (page E-33).
- Use (D) and (B) to select the city code you want.
 - Make sure you select your Home City code before changing any other setting.
 - For full information on city codes, see the "City Code Table" at the back of this manual.

E-9

3. Press **C** to change the flashing screen content in the sequence shown below to select the other settings.

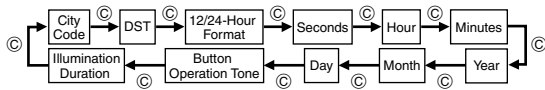

4. When the timekeeping setting you want to change is flashing, use **D** or **B** to change it as described below.

| Screen: | To do this: | Do this: |
|------------|---|--|
| TYO: TOKYO | Change the city code | Use D (east) and B (west). |
| OFF | Toggle the DST setting between Daylight Saving Time (ON) and Standard Time (OFF). | Press D . |

E-10

| Screen: | To do this: | Do this: |
|-----------|--|------------------------------------|
| 12H | Toggle between 12-hour (12H) and 24-hour (24H) timekeeping | Press D . |
| 36 | Reset the seconds to 00 | Press D . |
| 0:00 | Change the hour and minutes | Use D (+) and B (-). |
| 2013 6.30 | Change the year, month, or day | |
| MUTE | Toggle the button operation tone between KEY (on) and MUTE (off) | Press D . |
| 1 | Toggle the display illumination duration between 1.5 seconds (1) and three seconds (3) | Press D . |

E-11

5. Press **A** to exit the setting mode.

- The day of the week is displayed automatically in accordance with the date (year, month, and day) settings.

Daylight Saving Time (DST)

Daylight Saving Time (summer time) advances the time setting by one hour from Standard Time. Remember that not all countries or even local areas use Daylight Saving Time.

To change the Daylight Saving Time (summer time) setting



- In the Timekeeping Mode, hold down **A** for about two seconds until "SET" appears on the lower display.
 - Note that keeping **A** depressed too long (for about five seconds) will cause a different type of setting mode to be entered (page E-33).
- Press **C**. This will display the DST setting screen.

E-12 DST indicator

3. Use **D** to toggle the DST setting on and off.

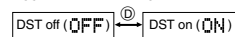

- The default DST setting is OFF (OFF).
- When the setting you want is selected, press **A** to exit the setting mode.
- The DST indicator appears to indicate that Daylight Saving Time is turned on.

12-hour and 24-hour timekeeping

- With the 12-hour format, the PM indicator (P) appears on the lower display for times in the range of noon to 11:59 p.m. and no indicator appears for times in the range of midnight to 11:59 a.m.
- With the 24-hour format, times are displayed in the range of 0:00 to 23:59, without the PM indicator (P).
- The 12-hour/24-hour timekeeping format you select in the Timekeeping Mode is applied in all other modes.

E-13

Stopwatch

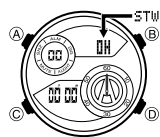

- You can use the stopwatch to measure elapsed time and split times.
- The digital display range of the stopwatch is 999 hours, 59 minutes, 59.99 seconds. The stopwatch continues to run until you stop it. If it reaches the above limit, it will restart the time measurement from zero.
 - The stopwatch operation continues even if you exit the Stopwatch Mode.
 - All of the operations in this section are performed in the Stopwatch Mode, which you enter by pressing **C** (page E-7).

E-14

Elapsed Time Measurement

- In the Stopwatch Mode, press **D** to start and stop elapsed time measurement.
- Pressing **A** while elapsed time measurement is in progress will display the current split time.

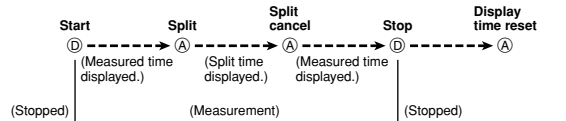

E-15

Measured time or split time

- Hours
- Alternates with "SPL" during split time display.

1/100 seconds

Minutes, seconds

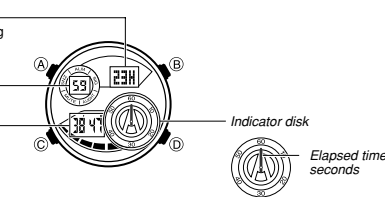

- Pressing **D** without resetting the displayed time will restart elapsed time measurement from where it was last stopped (cumulative elapsed time measurement).
- An ongoing elapsed time measurement operation continues even if you exit the Stopwatch Mode. In this case, the indicator disk indicates the current minutes count.

E-16

Countdown Timer

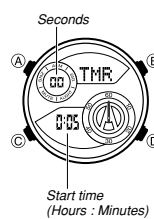

- You can set the countdown timer start time within a range of one minute to 24 hours. An alarm sounds when the countdown reaches zero.
- All of the operations in this section are performed in the Countdown Timer Mode, which you enter by pressing **C** (page E-7).

E-17

To use the countdown timer

- Press **D** while in the Countdown Timer Mode to start the countdown timer.
- When the end of the countdown is reached, the alarm will sound for 10 seconds or until you stop it by pressing any button.
 - The countdown time is reset to its starting value automatically after the alarm stops.
 - Press **D** while a countdown operation is in progress to pause it. Press **D** again to resume the countdown.
 - To stop a countdown timer operation completely, first pause it (by pressing **D**), and then press **A**. This returns the countdown time to its starting value.

To configure countdown start time settings

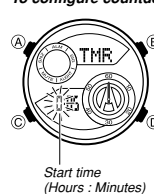

- While the countdown start time is on the display in the Countdown Timer Mode, hold down **A** for about two seconds until the hour setting of the countdown start time starts to flash. This is the setting mode.
 - Holding down **A** will initially cause "Hold" to appear on the screen. Keep **A** depressed until "Hold" disappears.
 - If the countdown start time is not displayed, use the procedure under "To use the countdown timer" (page E-18) to display it.
- Press **C** to move the flashing in the sequence shown below, and select the setting you want to change.

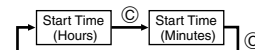

3. Press **A** to exit the setting mode.

E-18

E-19

World Time

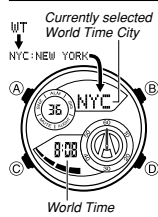

World Time digitally displays the current time in one of 48 cities (29 time zones) around the world. A simple operation swaps your Home City with the currently selected World Time City.

- The times kept in the World Time Mode are synchronized with the time being kept in the Timekeeping Mode. If you feel that there is an error in any World Time Mode time, check to make sure you have the correct city selected as your Home City. Also check to make sure that the current time as shown in the Timekeeping Mode is correct.
- Times in the World Time Mode are based on UTC offsets. See the "City Code Table" at the back of this manual for information about the UTC offsets that are supported.

- All of the operations in this section are performed in the World Time Mode, which you enter by pressing (C) (page E-7).

E-20

To view the current time in another time zone

In the World Time Mode, use (D) to scroll through available city codes (time zones). Holding down the button scrolls at high speed.

- The lower display shows the current time in the World Time City.
- To select the UTC time zone (Differential 0), press (B) and (D) at the same time.
- When the city code (time zone) you want is selected, you can press (A) to display the date. After about one second, the watch will resume regular timekeeping for the currently selected city.

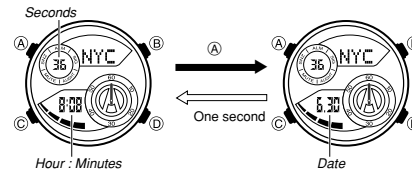

E-21

To toggle a city code time between Standard Time and Daylight Saving Time

- In the World Time Mode, press (D) to display the city code (time zone) whose Standard Time/Daylight Saving Time setting you want to change.
 - Hold down (A) for about two seconds to toggle between Daylight Saving Time (DST indicator displayed) and Standard Time (DST indicator not displayed).
- Holding down (A) will initially cause "Hold" to appear on the screen. Keep (A) depressed until "Hold" disappears.
 - The DST indicator is shown in the lower display while Daylight Saving Time is turned on.
 - You can turn on DST individually for each city code, except UTC.
 - Turning on DST for the city code that is currently selected as your Home City will turn on DST for normal timekeeping.

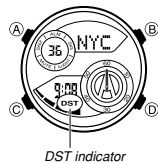

E-22

Swapping your Home City and World Time City

You can use the procedure below to swap your Home City and World Time City. This changes your Home City to your World Time City, and your World Time City to your Home City. This capability can come in handy when you frequently travel between two cities in different time zones.

To swap your Home City and World Time City

- In the World Time Mode, use (D) to select the World Time City you want.
 - Press (A) and (B) at the same time until the watch beeps.
- This will make the World Time City you selected in step 1 your Home City, and cause the hour and minute hands to move to the current time in that city. At the same time, it will change the Home City you had selected prior to step 2 your World Time City, and cause the content of lower display to change accordingly.
 - After swapping the Home City and World Time City, the watch stays in the World Time Mode with the city that was selected as the Home City prior to step 2 now displayed as the World Time City.

E-23

Alarms

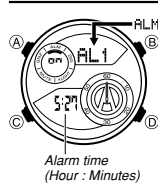

When an alarm is turned on, the alarm tone will sound when its alarm time is reached. One of the alarms is a snooze alarm, while the other four are daily alarms. You also can turn on an Hourly Time Signal that causes the watch to beep twice every hour on the hour.

- The snooze alarm screen is indicated by SNZ, while the other alarm screens are numbered AL.1 through AL.4.
- The Hourly Time Signal screen is indicated by SIG.
- All of the operations in this section are performed in the Alarm Mode, which you enter by pressing (C) (page E-7).

E-24

To set an alarm time

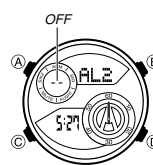

- In the Alarm Mode, use (D) to scroll through the alarm screens until the one whose time you want to set is displayed.



- To set an alarm time, display the applicable alarm screen (AL.1 through AL.4, or SNZ).
- SIG is the hourly time signal setting (page E-28).
- The snooze alarm operation repeats every five minutes.

- After you select an alarm, hold down (A) for about two seconds until the hour setting of the alarm time starts to flash. This is the setting mode.
 - Holding down (A) will initially cause "Hold" to appear on the screen. Keep (A) depressed until "Hold" disappears.
 - This operation turns on the alarm automatically.
- Press (C) to move the flashing between the hour and minute settings.

E-25

- While a setting is flashing, use (D) (+) and (B) (-) to change it.
- Press (A) to exit the setting mode.

Alarm Operation

The alarm tone sounds at the preset time for 10 seconds, regardless of the mode the watch is in. In the case of the snooze alarm, the alarm operation is performed a total of seven times, every five minutes, or until you turn the alarm off (page E-27).

- Alarm and Hourly Time Signal operations are performed in accordance with the current time in your Home City, as kept in the Timekeeping Mode.
- To stop the alarm tone after it starts to sound, press any button.
- Performing any one of the following operations during a 5-minute interval between snooze alarms cancels the current snooze alarm operation.
 - Displaying the Timekeeping Mode setting screen (page E-9)
 - Displaying the SNZ setting screen (page E-25)

To test the alarm

In the Alarm Mode, hold down (D) to sound the alarm.

E-26

To turn an alarm on and off

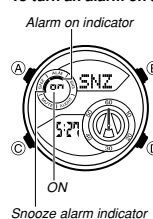

- In the Alarm Mode, use (D) to select an alarm.
 - Press (A) to toggle it on and off.
- Turning on an alarm (AL.1, AL.2, AL.3, AL.4 or SNZ) displays the alarm on indicator on its Alarm Mode screen.
 - In all modes, the alarm on indicator is shown for any alarm that currently is turned on.
 - The alarm on indicator flashes while the alarm is sounding.
 - The snooze alarm indicator flashes while the snooze alarm is sounding and during the 5-minute intervals between alarms.

E-27

To turn the Hourly Time Signal on and off

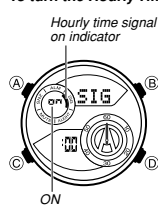

- In the Alarm Mode, use (D) to select the Hourly Time Signal (SIG) (page E-25).
 - Press (A) to toggle it on and off.
- The Hourly Time Signal on indicator is shown on the display in all modes while this function is turned on.

E-28

Illumination

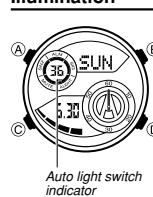

An LED (light-emitting diode) illuminates the face of the watch for easy reading in the dark. The watch's auto light switch turns on illumination automatically when you angle the watch towards your face.

- The auto light switch must be turned on (indicated by the auto light switch indicator) for it to operate.
- See "Illumination Precautions" (page E-38) for other important information about using illumination.

To illuminate the display manually

- In any mode, press (B) to turn on illumination.
- The above operation turns on illumination regardless of the current auto light switch setting.
 - You can use the procedure below to select either 1.5 seconds or 3 seconds as the illumination duration. When you press (B), the illumination will remain on for about 1.5 seconds or 3 seconds, depending on the current illumination duration setting.

E-29

To specify the illumination duration

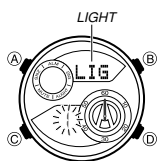

- In the Timekeeping Mode, hold down (A) for about two seconds until "SET" appears on the lower display.
 - Note that keeping (A) depressed too long (for about five seconds) will cause a different type of setting mode to be entered (page E-33).
- Press (C) ten times to display the current illumination duration 1 or 3.
- Press (D) to toggle the setting between 1 (1.5 seconds) and 3 (three seconds).
- Press (A) to exit the setting screen.

E-30

About the Auto Light Switch

Turning on the auto light switch causes illumination to turn on, whenever you position your wrist as described below in any mode.

Moving the watch to a position that is parallel to the ground and then tilting it towards you more than 40 degrees causes illumination to turn on.

- Wear the watch on the outside of your wrist.



E-31

Warning!

- Always make sure you are in a safe place whenever you are reading the display of the watch using the auto light switch. Be especially careful when running or engaged in any other activity that can result in accident or injury. Also take care that sudden illumination by the auto light switch does not startle or distract others around you.
- When you are wearing the watch, make sure that its auto light switch is turned off before riding a bicycle or operating a motorcycle or any other motor vehicle. Sudden and unintended operation of the auto light switch can create a distraction, which can result in a traffic accident and serious personal injury.

To turn the auto light switch on and off

In the Timekeeping Mode, hold down (B) for about three seconds to toggle the auto light switch on (auto light switch indicator displayed) and off (auto light switch indicator not displayed).

- The auto light switch indicator remains in all modes while the auto light switch is turned on.
- In order to protect against running down the battery, the auto light switch will turn off automatically approximately six hours after you turn it on. Repeat the above procedure to turn the auto light switch back on if you want.

E-32

Hand Home Position Correction

The indicator disk and hour and minute hands of the watch can be thrown off by exposure to strong magnetism or impact. If this happens, you can correct analog readings as required.

To adjust home positions



Correct indicator disk position

- In the Timekeeping Mode, hold down (A) for about five seconds until H-SET (H:SET) appears in the upper display and Sub (Sub) appears in the lower display.
- Check the position of the indicator disk.
 - The indicator disk is in the correct home position if it is indicating 60 (12 o'clock position). If it is not correct, use the (D) (+) and (B) (-) buttons to adjust it.
 - After confirming that the indicator disk is in its correct home position, press (C).

E-33

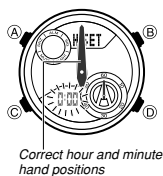

Correct hour and minute hand positions

- Check the positions of the hour and minute hands.
 - The hands are in the correct home positions if they are pointed at 12 o'clock. If they aren't, use (D) (clockwise) and (B) (counterclockwise) to adjust their positions.
- When everything is the way you want, press (A) to return to regular timekeeping.
 - This will cause the hour and minute hands to move to the current Timekeeping Mode time and the indicator disk to move to the 0 position.
 - Pressing (C) here will return to the setting at the beginning of step 2.

E-34

Reference

This section contains more detailed and technical information about watch operation. It also contains important precautions and notes about the various features and functions of this watch.

Button Operation Tone

Mute indicator



The button operation tone sounds any time you press one of the watch's buttons. You can turn the button operation tone on or off as desired.

- Even if you turn off the button operation tone, alarms, the Hourly Time Signal, and other beepers all operate normally.

E-35

To turn the button operation tone on and off

- In the Timekeeping Mode, hold down (A) for about two seconds until "SET" appears on the lower display.
 - Note that keeping (A) depressed too long (for about five seconds) will cause a different type of setting mode to be entered (page E-33).
- Press (C) nine times until the current button operation tone setting (KEY or MUTE) appears.
- Press (D) to toggle the setting between KEY (tone on) and MUTE (tone off).
- Press (A) to exit the setting screen.
 - The mute indicator is displayed in all modes when the button operation tone is turned off.

Auto Return Features

- If you leave the watch with a flashing setting on the display for two or three minutes without performing any operation, the watch will exit the setting mode automatically.
- The watch will return to the Timekeeping Mode automatically if you do not perform any operation for two or three minutes in the Alarm Mode.

E-36

High-Speed Movement

- The (D) and (B) buttons are used to change setting in various setting modes. In most cases, holding down these buttons will start high-speed movement.

Initial Screens

When you enter the Stopwatch Mode, World Time Mode or Alarm Mode, the data you were viewing when you last exited the mode will appear first.

Timekeeping

- Resetting the seconds to 00 while the current count is in the range of 30 to 59 causes the minutes to be increased by 1. In the range of 00 to 29, the seconds are reset to 00 without changing the minutes.
- The year can be set in the range of 2000 to 2099.
- The watch's built-in full automatic calendar makes allowances for different month lengths and leap years. Once you set the date, there should be no reason to change it except when battery has replaced.
- The current time for all city codes in the Timekeeping Mode and World Time Mode is calculated in accordance with the Coordinated Universal Time (UTC) for each city, based on your Home City time setting.

E-37

Illumination Precautions

- Illumination may be difficult to see when viewed under direct sunlight.
- Illumination turns off automatically whenever an alarm sounds.
- Illumination turns off automatically depends on the current illumination duration setting.
- Frequent use of illumination runs down the battery.

Auto light switch precautions

- Avoid wearing the watch on the inside of your wrist. Doing so causes the auto light switch to operate when it is not needed, which shortens battery life. If you want to wear the watch on the inside of your wrist, turn off the auto light switch feature.

More than 15 degrees too high

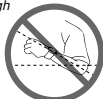

- Illumination may not turn on if the face of the watch is more than 15 degrees above or below parallel. Make sure that the back of your hand is parallel to the ground.
- Illumination turns off in about 1.5 seconds or 3 seconds, even if you keep the watch pointed towards your face.

E-38

- Static electricity or magnetic force can interfere with proper operation of the auto light switch. If illumination does not turn on, try moving the watch back to the starting position (parallel with the ground) and then tilt it back toward you again. If this does not work, drop your arm all the way down so it hangs at your side, and then bring it back up again.
- Under certain conditions, illumination may not turn on until about one second after you turn the face of the watch towards you. This does not necessarily indicate malfunction of the auto light switch.
- You may notice a very faint clicking sound coming from the watch when it is shaken back and forth. This sound is caused by mechanical operation of the auto light switch, and does not indicate a problem with the watch.

E-39

Operation Guide 5346

CASIO®

Specifications

Accuracy at normal temperature: ± 15 seconds a month

Digital Timekeeping: Hour, minutes, seconds, p.m. (PM), month, day, day of the week

Time format: 12-hour and 24-hour

Calendar system: Full Auto-calendar pre-programmed from the year 2000 to 2099

Other: Home City code (can be assigned one of 48 city codes); Standard Time / Daylight Saving Time (summer time)

Analog Timekeeping: Hour, minutes (hand moves every 20 seconds)

Stopwatch:

Measuring unit: 1/100 second

Measuring capacity: 999:59:59.99"

Measuring accuracy: ±0.0006%

Measuring modes: Elapsed time, Split time

Indicator disk: Seconds

Countdown Timer:

Measuring unit: 1 second

Input range: 1 minute to 24 hours (1-minute increments)

World Time: 48 cities (29 time zones)

Other: Daylight Saving Time/Standard Time, Home City/World Time City Swapping

Alarms: 5 daily alarms (with 1 snooze alarm), Hourly Time Signal

Illumination: LED (light-emitting diode), Auto Light Switch; Selectable illumination duration

Other: Button operation tone on/off

Battery: Two silver oxide batteries (Type: SR927W)

Approximate Battery Life: 3 years on type SR927W

(ten seconds of alarm operation per day, one illumination operation (1.5 seconds) per day)

E-40

E-41



City Code Table



L-1

City Code Table

| City Code | City | UTC Offset/ GMT Differential |
|-----------|-------------|---------------------------------|
| PPG | Pago Pago | -11 |
| HNL | Honolulu | -10 |
| ANC | Anchorage | -9 |
| YVR | Vancouver | -8 |
| LAX | Los Angeles | -8 |
| YEA | Edmonton | -7 |
| DEN | Denver | -7 |
| MEX | Mexico City | -6 |
| CHI | Chicago | -6 |
| NYC | New York | -5 |
| SCL | Santiago | -4 |
| YHZ | Halifax | -4 |
| YYT | St. Johns | -3.5 |

L-2

| City Code | City | UTC Offset/ GMT Differential |
|-----------|---------------------|---------------------------------|
| RIO | Rio De Janeiro | -3 |
| FEN | Fernando de Noronha | -2 |
| RAI | Praia | -1 |
| UTC | | |
| LIS | Lisbon | 0 |
| LON | London | 0 |
| MAD | Madrid | 0 |
| PAR | Paris | 0 |
| ROM | Rome | +1 |
| BER | Berlin | +1 |
| STO | Stockholm | +1 |
| ATH | Athens | +2 |
| CAI | Cairo | +2 |
| JRS | Jerusalem | +2 |

| City Code | City | UTC Offset/ GMT Differential |
|-----------|-----------|---------------------------------|
| MOW* | Moscow | +3 |
| JED | Jeddah | +3 |
| THR | Tehran | +3.5 |
| DXB | Dubai | +4 |
| KBL | Kabul | +4.5 |
| KHI | Karachi | +5 |
| DEL | Delhi | +5.5 |
| KTM | Kathmandu | +5.75 |
| DAC | Dhaka | +6 |
| RGN | Yangon | +6.5 |
| BKK | Bangkok | +7 |

* The above is current as of December 2012. This watch does not reflect the change in the Moscow (MOW) time offset to +4. Because of this, you should leave the summer time setting turned on (which advances the time by one hour) for Moscow (MOW).

L-3

- This table shows the city codes of this watch.
- The rules governing global times (UTC offset and GMT differential) and summer time are determined by each individual country.

L-4